

GA800

AC Drives for Industrial Applications



Easy, Powerful, and Extremely Reliable...

At Yaskawa, we know your time is valuable. That's why we've designed this variable speed drive to exceed your expectations. Offering world class Yaskawa quality, along with intuitive interaction and high flexibility, the GA800 delivers powerful torque and precise control. Look no further than GA800 for all your variable speed needs.

... That's Our Commitment to You



Designed to control traditional and emerging motor technologies through 600 HP, the GA800 handles applications ranging from simple fans and pumps to high performance test dynamometers requiring precise regulation.

In addition to its robust and powerful design, the GA800 provides highly flexible network communications, embedded functional safety, and easy-to-use tools featuring mobile device connectivity.



200 - 240 VAC
1 - 150 HP

380 - 480 VAC
1 - 600 HP

Making it Easy for You

- Forget the learning curve. Let GA800 guide you through its Setup Wizard to get you up and running in a snap!
- Enjoy the GA800's intuitive keypad with a vivid display and a host of friendly features.
- Experience ultimate ease-of-use and flexibility with DriveWizard PC and Mobile tools featuring Bluetooth® connectivity and cloud services.

Making it Flexible for You

- Easily and impressively control all major 3-phase motors.
- Connect and control the GA800 from your favorite network.
- Customize GA800 from its rich set of control features.

Making it Sustainable for You

- Embedded Functional Safety reduces your down-time.
- Enjoy long life with conformal coated circuit boards and solutions for harsh environments.
- Electrical design that's friendly to your power system and surrounding equipment.
- Produced with materials responsible to our planet.

Bluetooth® and the Bluetooth logo are registered trademarks of Bluetooth SIG, Inc. USA.

One for All

The GA800 is the one drive you need for all types of motors. It precisely controls induction, permanent magnet and synchronous reluctance motors. Say goodbye to the days of complex motor setup!

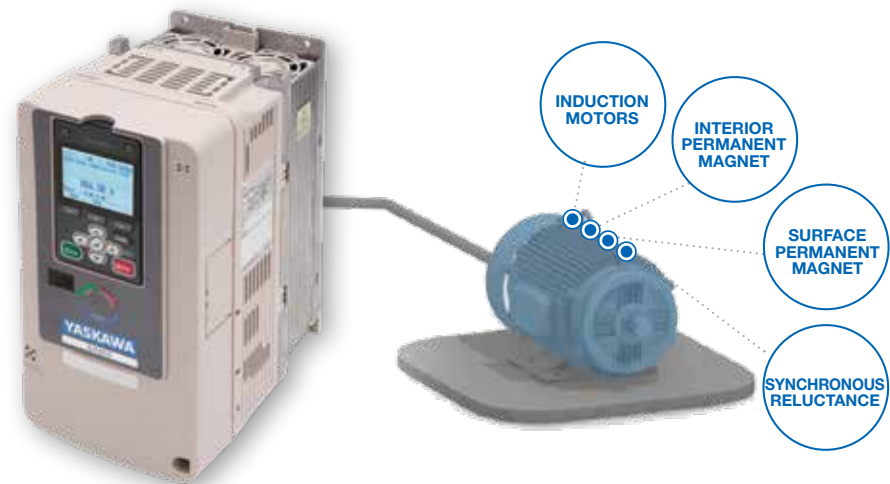

Motor Control Benefits/Features:

Flexible Motor Control

- Controls traditional and emerging motor technologies
- Easy and accurate autotuning provides optimized performance for each connected motor
- Optimized control avoids tripping even with aggressive settings
- Impressive open loop vector control
- Precise and high response closed loop vector control
- 590Hz maximum frequency
- 110% normal duty overload
- 150% heavy duty overload
- Integrated brake transistor up to 125 HP (ND) / 100 HP (HD)

Save Even MORE Energy!

Smart Power Saver mode reduces energy consumption at reduced speeds and loads for maximum efficiency and minimum operating costs

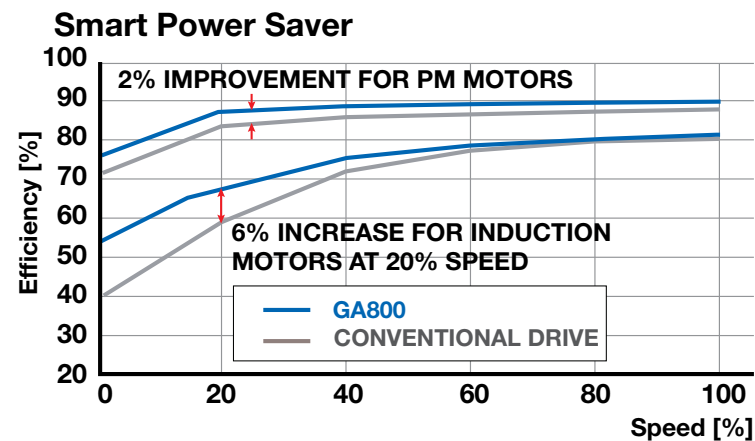

Any Way You Want It

Optimize your space, your way, by taking advantage of the GA800's installation flexibility.



Install Standard (IP20) Drives in Cabinets, Side-by-Side



Small ratings capable of zero side clearance. See product instructions for details.

Utilize NEMA 1 Kit For Cabinet-Less Installations



Install With Heatsink Exposed For Optimized Heat Management



Use standard drives with external heatsink for NEMA 1 environments

Use flange drives with external heatsink for NEMA 12 (dusty) environments

Get Connected

Whether you prefer discrete / analog control or high speed communication, GA800 covers all your needs for control interface and provides robust connections on all major networks.

Configurations

Ring

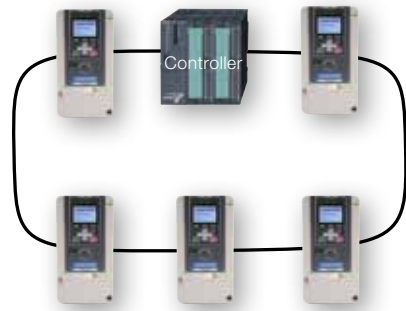

Star

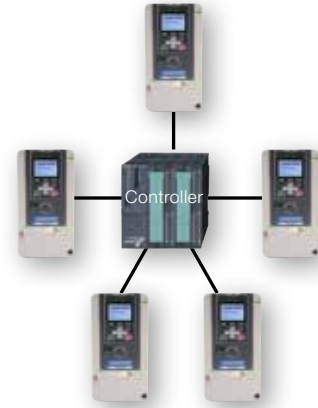

Line



Note: Node limitation dependent on network specific standards, other equipment, required network performance.



- Connect with standard network modules for conventional and robust star configurations
- Connect with dual port network modules and daisy-chain your connections for ring or line configurations. A great choice for decentralized drives
- Maintain control power with main power removed by supplying your 24VDC to the GA800's auxiliary input
- Connect up to 5 drives from a single network node by adding slave drives over the GA800's embedded RS-485



Removable standard control terminal board for easy wiring connections.

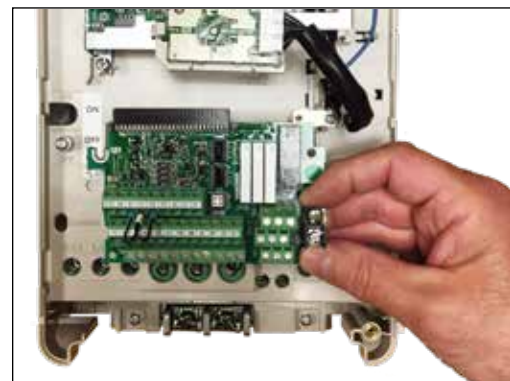

Standard Inputs

- RS-485 Modbus RTU
- 8 digital, 3 analog, 1 pulse
- Safe Torque Off
- 24VDC auxiliary power

Standard Outputs

- 4 digital, 2 analog, 1 pulse
- 24VDC supply for external sensors

Expansion modules available for additional I/O and encoder feedback

Zone Defense

When your application requires human interaction with mechanical dangers, the GA800 can help with its embedded functional safety.



A standard feature of the GA800 is Safe Torque Off, which prevents torque production to the motor even while main input power remains applied. This minimizes your downtime when people enter your mechanical safety zone. Normal operation is resumed faster.

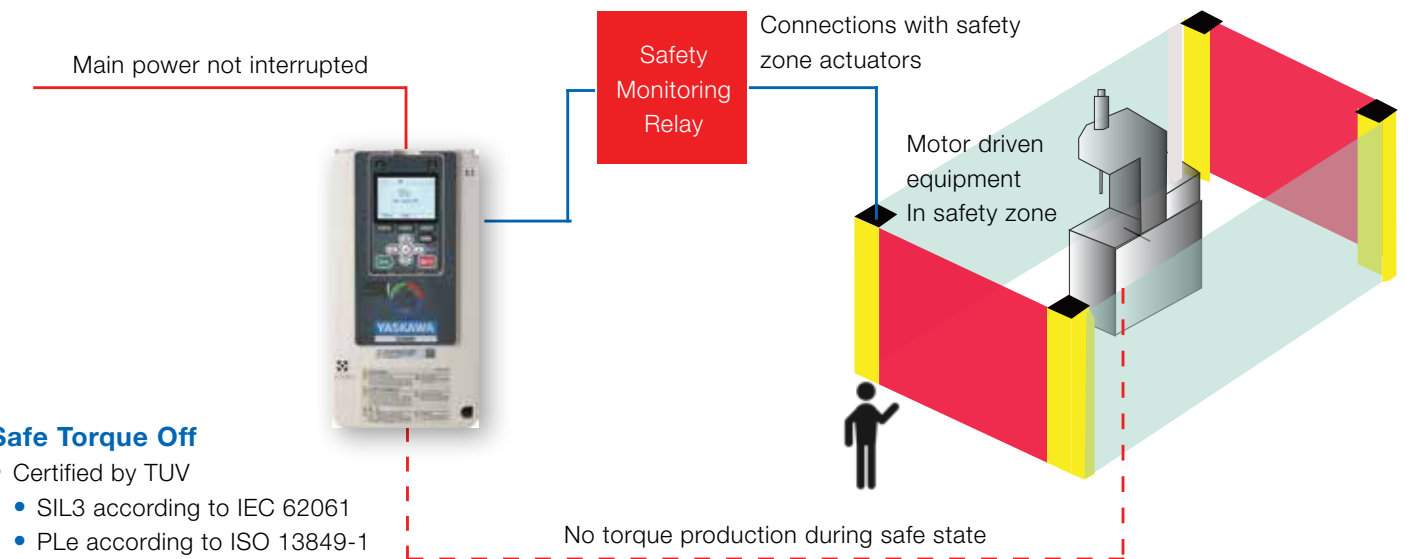

Safe Torque Off

- Certified by TUV
 - SIL3 according to IEC 62061
 - PLe according to ISO 13849-1
- Programmable EDM monitor output for status

For the Long Haul

Rugged and long lasting. These are the cornerstones of Yaskawa, where we apply the latest proven technology and processes, to provide products you can trust.

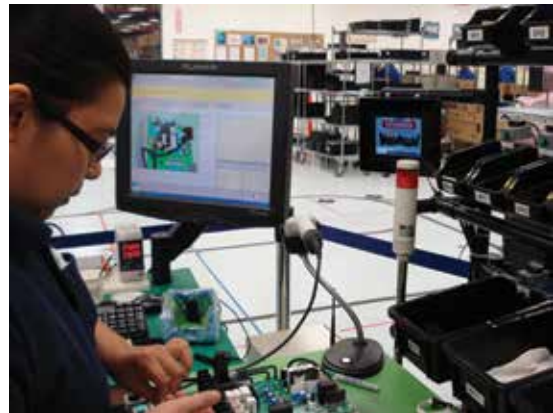

Product Testing

All Yaskawa products undergo rigorous testing during the design phase to ensure long life and problem-free operation.

- Maximum Temperature
- Maximum Load
- Maximum Voltage and Hi-Pot
- Electromagnetic Compatibility

Product Certification

Designed to the most stringent electrothermal safety standards and certified with all major worldwide agencies

- UL and CSA
- TUV
- CE
- EAC
- RCM
- KCC



Planet Fitness

Whether your concern is efficiency, power quality, or non-hazardous materials, Yaskawa products help you contribute to a healthy and sustainable environment.

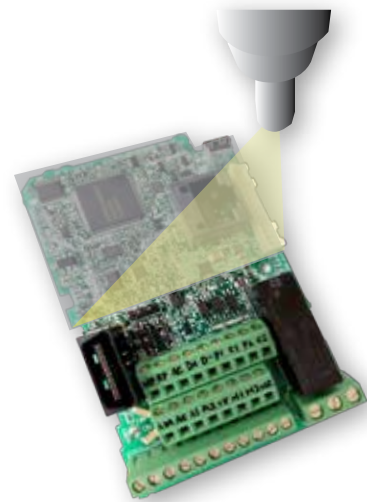

Coated Board Protection

In addition to an extremely robust design, we understand your environment may be less than perfect for electronics. That's why we've stacked the deck in your favor with conformal coating on all circuit boards to provide some "extra protection", meeting IEC 60721-3-3, 3C2, 3S3 levels.



Your Power-Friendly Partner

- Ability to control highly efficient permanent magnet motors
- Integrated DC reactors and a 12-Pulse-Ready version for improved power factor and harmonic distortion

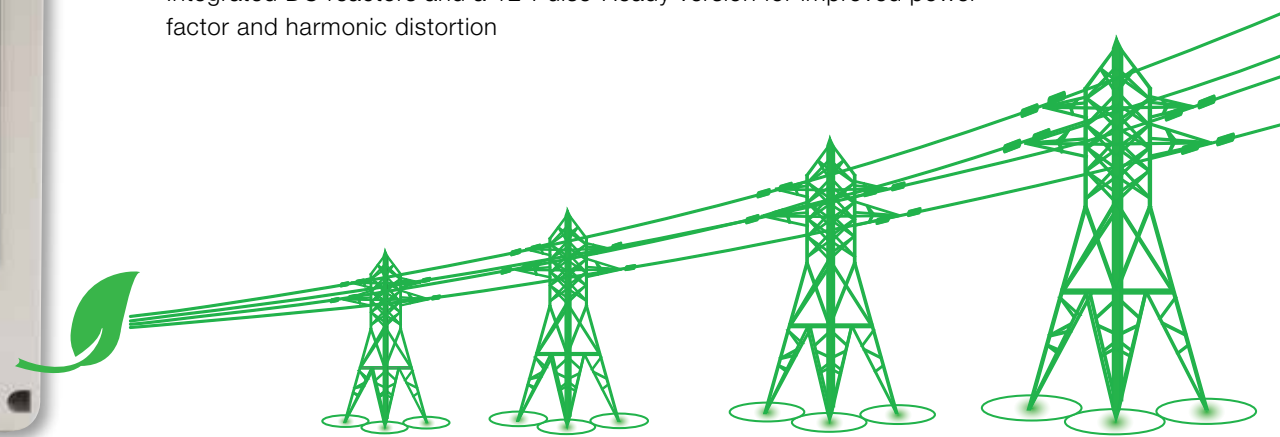

RoHS
compliant

Zero Tolerance

Rest assured that Yaskawa complies with strict environmental standards relative to use of hazardous substances.

Products are certified to the RoHS 2 Directive (2011/65/EU), which permits very small levels of lead, mercury, cadmium and others substances.

Convenient and Effortless

It's so easy! Use the GA800's resident keypad, your mobile device, or your personal computer. Whatever you choose, enjoy easy navigation and guided wizards for configuration, monitoring, and troubleshooting.

DriveWizard Mobile

- Optional Bluetooth® enabled keypad provides wireless connection to your smart-phone or tablet where you can experience colorful attractive dialog with the GA800.
- Alternatively, connect via USB, and interface with the GA800 even without main power!



Let Us Keep That Somewhere Safe for You!



Backup your drive settings by taking advantage of free cloud service from Yaskawa. Access the Yaskawa Drive Cloud from anywhere in the world via DriveWizard Mobile or from the web.

Yaskawa Drive Cloud

- Scan the GA800's QR code to locate existing cloud data or initiate new cloud data with drive identification pre-populated.
- Register, store and retrieve your personal drive configuration files unique to each serial number.
- Free storage of drive information including photos and other common file types.



Push My Buttons!

The GA800 standard interface provides you with a crisp large display that's intuitive and loaded with capability.

Copy Function

Multiple parameter sets can be stored and easily transferred to additional drives

High-Resolution Display

Large multi-language screen with contrast and backlight control

Automatic Back-up Function

Periodically copies parameters to keypad memory for safe keeping

Advanced Keypad Navigation

Fast scrolling, function keys, and shortcuts reduce your setup time

Setup Wizard

Reduce configuration time using the setup wizard without any drive parameter knowledge.



Micro SD Storage

Expandable memory (up to 32GB) for data logging storage

Real-Time Clock

For stamping your events with dates and times. Battery powered.

Optional LCD Keypad With Bluetooth®

Wireless communication with your mobile device

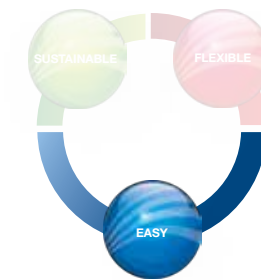

Powerful Made Easy

Unleash all that GA800 has to offer with Yaskawa's intuitive and flexible PC-based interface tools. Enjoy DriveWizard® Desktop for configuring, advanced monitoring, trending, and file storage. Create custom functions with DriveWorksEZ®.

DriveWizard Desktop

- Connect via USB and interface with the GA800 even without main power!
- Create configurations offline, then later connect and download them to GA800.
- Monitor a dashboard of dynamic variables and discrete information.
- Chart your process with up to 6 channels of recorded data.
- Create reports for exporting and emailing.

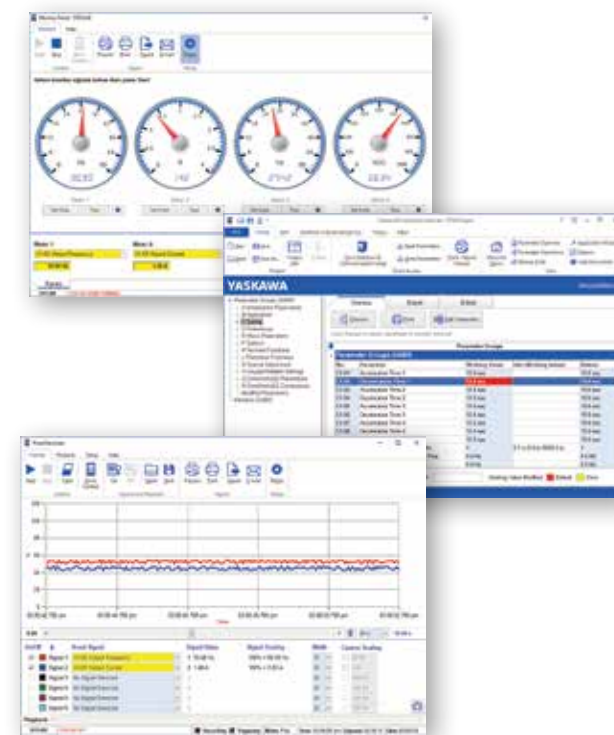

DriveWorksEZ

- Drag-n-drop graphical interface
- Select from 280+ function blocks
- Logic/math functions
- Timers/counters
- Up to 200 connections, 400 blocks
- Constant scan cycle

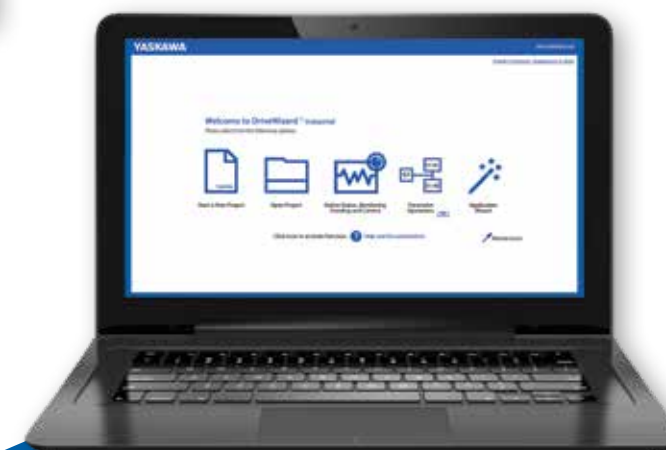

DriveWizard and DriveWorksEZ are registered trademarks of Yaskawa.

Ratings

Catalog Code Designation

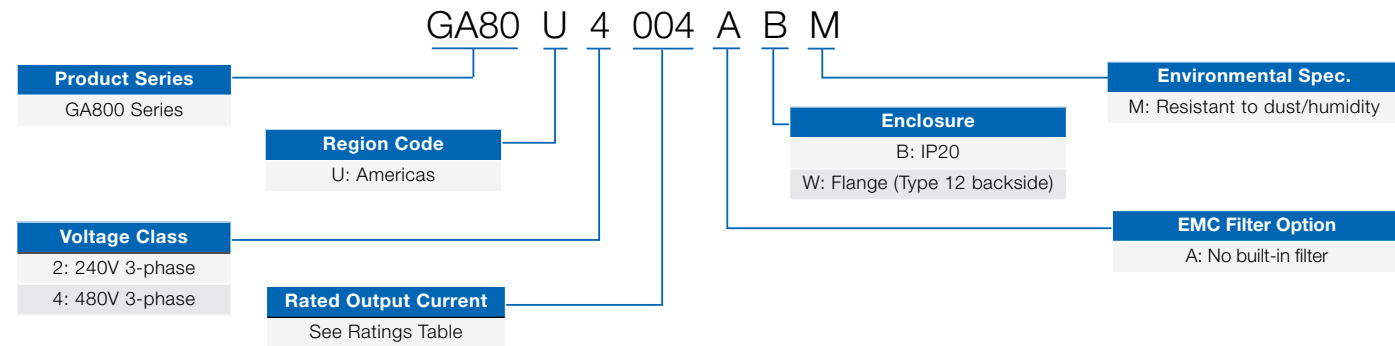

Ratings

Power Output (HP)		240V Drives				480V Drives			
Normal Duty (ND)	Heavy Duty (HD)	Catalog Code GA80U	Output Amps		Frame	Catalog Number GA80U	Output Amps		Frame
			ND	HD			ND	HD	
1.0	0.75	2004ABM	4.2	3.5	1	4002ABM	2.1	1.8	1
1.5	1	2006ABM	6	5	1				
2	1.5	2008ABM	8	6.9	1	4004ABM	4.1	3.4	1
3	2	2010ABM	9.6	8	1	4005ABM	5.4	4.8	1
4	3	2012ABM	12.2	11	1	4007ABM	7.1	5.5	1.5
5	4	2018ABM	17.5	14	1.5	4009ABM	8.9	7.2	1.5
7.5	5	2021ABM	21	17.5	1.5	4012ABM	11.9	9.2	1.5
10	7.5	2030ABM	30	25	1.5	4018ABM	17.5	14.8	1.5
15	10	2042ABM	42	33	1.5	4023ABM	23.4	18	1.5
20	15	2056ABM	56	47	2	4031ABM	31	24	2
25	20	2070ABM	70	60	3	4038ABM	38	31	2
30	25	2082ABM	82	75	3	4044ABM	44	39	3
40	30	2110ABM	110	88	4	4060ABM	59.6	45	3.5
50	40	2138ABM	138	115	6	4075ABM	74.9	60	4
60	50	2169ABM	169	145	7	4089ABM	89.2	75	6
75	60	2211ABM	211	180	7	4103ABM	103	91	6
100	75	2257ABM	257	215	9	4140ABM	140	112	7
125	100	2313ABM	313	283	9	4168ABM	168	150	7
150	125	2360ABM	360	346	10	4208ABM	208	180	9
150	150	2415ABM	415	415	10				
200	150					4250ABM	250	216	9
250	200					4302ABM	302	260	9
300	250					4371ABM	371	304	10
350	300					4414ABM	414	371	10
400	350					4477ABM	477	414	11
450	400					4568ABM	568	477	11
500	450					4605ABM	675	605	11
600	500					4720ABM	720	605	11

Approximate Dimensions

Frame	Height	Width	Depth
1	10.2 (260)	5.51 (140)	6.93 (176)
1.5	10.2 (260)	5.51 (140)	8.31 (211)
2	11.8 (300)	7.09 (180)	7.95 (202)
3	13.8 (350)	8.66 (220)	8.94 (227)
3.5	13.8 (350)	8.66 (220)	9.69 (246)
4	15.7 (400)	9.45 (240)	11.0 (280)
6	17.7 (450)	10.0 (255)	11.0 (280)
7	21.4 (543)	10.4 (264)	13.2 (335)
9	27.6 (700)	12.3 (312)	16.5 (420)
10	31.5 (800)	17.3 (440)	18.6 (472)
11	44.72 (1136)	20.1 (510)	18.9 (480)

Dimensions shown in inches (mm).
Information on this page represents IP20 type enclosures. For other enclosure types and enclosure adapters, please visit yaskawa.com.

Specifications



Item	Specification
Overload Capacity	150% for 60 sec. (HD), 110% for 60 sec. (ND)
Output Frequency	0 to 590 Hz
Control Methods	Open and Closed Loop Current Vector Open and Closed Loop V/f
Motor Types	Induction Surface Permanent Magnet Interior Permanent Magnet Synchronous Reluctance
Protective Design Types	IP20 (NEMA 1 kit available) Flange (Type 12 backside)
Ambient Operating Temperature	-10 to +50°C (IP20 and flange types) -10 to +40°C (with NEMA 1 kit) Up to +60°C (with derate)
Global Certifications	UL, CSA, CE, RCM, RoHS
Functional Safety	Safe Torque Off, SIL3 according to IEC 62061, PLe according to ISO 13849-1
Standard I/O	(8) multi-function digital inputs (24Vdc) (3) multi-function analog inputs (0 +/- 10 VDC, 4-20 mA) (1) multi-function pulse inputs (2) Safe Torque Off inputs (1) fault relay output (form C) (3) multi-function relay outputs (form A)
I/O Expansion	(2) multi-function analog output (0 +/- 10 VDC, 4-20mA) (1) multi-function pulse output (3) Analog Inputs -10 to +10V, 13 bit plus sign, 4 to 20mA (16) Digital Inputs (2) Analog Outputs (-10 to +10V, 11 bit magnitude) (8) Digital Outputs (6 transistor, 2 relay)
Feedback (optional)	Incremental Absolute (Stegmann, Heidenhain, Resolver)
Network Communication	Standard: Modbus RTU, RS-485, 115 kbps Optional: EtherNet/IP, DeviceNet, Modbus TCP/IP, PROFINET, PROFIBUS-DP
Speed Control Range	1500:1 Closed Loop Vector (IM and PM Motors) 200:1 Open Loop Vector (IM Motors) 100:1 Open Loop Vector (PM Motors)
Speed Control Accuracy	≤ 0.02%: Closed Loop Vector; ≤ 0.2%: Open Loop Vector
Speed Response	≥ 50 Hz: Closed Loop Vector (Induction Motors); ≥ 250 Hz: Closed Loop Vector (PM Motors) ≥ 20 Hz: Open Loop Vector (Induction Motors); ≥ 40 Hz: Open Loop Vector (PM Motors)
Function Block Diagrams	Up to 200 connections, 500us program scan time



Yaskawa is the leading global manufacturer of low and medium voltage variable frequency drives, servo systems, machine controllers and industrial robots. Our standard products, as well as tailor-made solutions, are well known and have a high reputation for outstanding quality and reliability.